



## SoLED W840



## USER MANUAL

### **TMB 24/7 Technical Support**

US/Canada: +1 818.794.1286

Toll Free: 1 877.862.3833 (877.TMB.DUDE)

UK: +44 (0)20.8574.9739

Toll Free: 0800.652.5418

e-mail: [techsupport@tmb.com](mailto:techsupport@tmb.com)

Innovative, Performance-Driven Show Technology Since 1983

tmb.com

Los Angeles

London

New York

Beijing

Toronto

+1 818-899-8818

+44 (0)20-8574-9700

+1 201-896-8600

+86 10-8492-1587

+1 519-538-0888



# TABLE OF CONTENTS

<b>1. INTRODUCTION .....</b>	<b>3</b>
PRODUCT OVERVIEW .....	3
WHAT IS INCLUDED .....	3
UNPACKING INSTRUCTIONS .....	3
POWER REQUIREMENTS .....	3
FREQUENCY SETTING .....	3
SAFETY INSTRUCTIONS.....	4
<b>2. SETUP .....</b>	<b>4</b>
FUSE REPLACEMENT.....	4
FIXTURE LINKING .....	5
DMX DATA CABLE.....	5
CABLE / CONNECTORS .....	5
3-PIN TO 5-PIN CONVERSION CHART.....	6
SETTING UP A DMX SERIAL DATA LINK .....	6
FIXTURE MOUNTING / RIGGING.....	7
<b>3. OPERATING INSTRUCTIONS .....</b>	<b>7</b>
CONTROL PANEL NAVIGATION.....	7
MENU MAP .....	9
FUNCTION DESCRIPTION.....	10
STROBE MODES .....	11
EFFECTS DESCRIPTIONS .....	12
MANUAL MODE.....	13
MEASURE .....	15
THERMOMETER .....	16
<b>4. APPENDIX .....</b>	<b>17</b>
GENERAL MAINTENANCE .....	17
LIMITED WARRANTY.....	17
RETURN PROCEDURE .....	18
CONTACT INFORMATION .....	18
TECHNICAL SPECIFICATION.....	19
DIMENSIONAL DRAWINGS .....	20

# 1. INTRODUCTION

## PRODUCT OVERVIEW

The Solaris SoLED W840 white LED strobe offers the same look and feel as xenon strobes at a fraction of the power consumption. Using high-intensity Cree® LEDs, the SoLED provides ultra-bright whites with 92,000 lumen peak output. Compact and lightweight, the SoLED is very portable and hides well in any application.

- Ultra-bright – 840 Watts of brilliant white output, 92,000lm peak output
- Compact and lightweight – Fits almost anywhere
- Easy to use – Same control modes and personalities as other popular strobes
- DMX512 with RDM – Easy to control plus continual operational feedback
- LED design – Longer life than xenon lamps for reliability and long-term cost savings
- Built-in yoke – Application and mounting flexibility
- Fan-free – Quiet operation, perfect for theatre, film, and TV use

## WHAT IS INCLUDED

- 1x Solaris W840 fixture
- 1x Power cable
- 1x User Manual

## UNPACKING INSTRUCTIONS

Upon receipt of the fixture, carefully unpack the carton and check the contents to ensure that all parts are present and in good condition. Notify the shipper immediately and retain packing material for inspection if any parts appear to be damaged from shipping or if the carton itself shows signs of mishandling. Save the carton and all packing materials. In the event that a fixture must be returned to the factory, it is important that the fixture be returned in the original factory box and packing.

## POWER REQUIREMENTS

Before powering the unit, make sure the line voltage is within the range of accepted voltages. This fixture accommodates 100-240VAC, 50/60Hz. All fixtures must be powered directly from a switched circuit and cannot be operated with a rheostat (variable resistor) or dimmer circuit, even if the rheostat or dimmer channel is used solely as a 0-100% switch.

When powered up, SoLED performs a preprogrammed internal test. On initial power-up the factory default DMX address appears on the display screen and SoLED is ready for operation. After initial power-up, the last-saved DMX address will appear.

## FREQUENCY SETTING

Depending on location, change the Default Frequency setting to match the mains power (e.g., US and Canada should be set at 60Hz). Proper frequency setting will ensure minimum amount of visible artifacts when using Solaris on camera.

## SAFETY INSTRUCTIONS



Please read these instructions carefully. This user guide contains important information about the installation, usage and maintenance of this fixture.

- Please keep this Operation Manual for future reference. If unit is sold to another user, make sure they also receive this instruction booklet.
- Ensure fixture is connected to proper voltage, and that line voltage is not higher than that stated on the fixture.
- Make sure there are no flammable materials close to the unit while operating.
- Always disconnect from the power source before servicing or fuse replacement. Always use the fuse specified in this manual.
- Always use a safety cable when hanging fixture overhead.
- Maximum ambient temperature (Ta) is 40°C (104°F). Do not operate fixture at temperatures above this rating.
- In the event of a serious operating problem, stop using the unit immediately. Repairs must be carried out by trained, authorized personnel. Contact the nearest authorized technical assistance center. Only OEM spare parts should be used.
- Do not connect the device to a dimmer pack.
- Make sure power cord is never crimped or damaged.
- Never disconnect power cord by pulling or tugging on the cord.
- Avoid direct eye exposure to the light source during operation.

**Caution!** *There are no user serviceable parts inside the unit. Do not open the housing or attempt any repairs yourself. In the unlikely event your unit may require service, please contact your distributor.*

## 2. SETUP



Disconnect the power cord before replacing the fuse. Always replace with the correct fuse type.



### FUSE REPLACEMENT

SoLED uses a 12A 250V slow-blow fuse. To replace fuse:

1. With a screwdriver turn the fuse cap counter-clockwise to remove fuse cap with fuse.
2. Replace fuse attached to fuse cap.
3. Reinsert fuse cap with new fuse and tighten clockwise.

## FIXTURE LINKING

A DMX data link is needed to operate one or more fixtures with a DMX-512 lighting console. The combined number of channels required by all of the fixtures on the DMX data link will determine the number of fixtures the DMX data link can support. Maximum recommended DMX data link distance between fixtures: 984 ft. (300 meters).

**Important:** Fixtures on a DMX data link must be daisy-chained in one single line. To comply with the EIA-485 standard, no more than 32 devices should be connected on one data link. Connecting more than 32 fixtures on one serial data link without the use of a DMX optically-isolated splitter may result in deterioration of the digital DMX signal.

## DMX DATA CABLE

Use a ProPlex® DMX cable or equivalent which meets the specifications for EIA RS-485 applications. Standard microphone cables cannot transmit DMX data reliably over long distances. The data cable must have the following characteristics:

- 2-conductor twisted pair plus a shield
- Max. capacitance between conductors – 30 pF/ft.
- Max. capacitance between conductor and shield – 55 pF/ft.
- Max. resistance of 20 ohms / 1000 ft.
- Nominal impedance 100-140 ohms

## CABLE / CONNECTORS

Cabling must have a male XLR connector on one end and a female XLR connector on the other end.

### DMX connector configuration

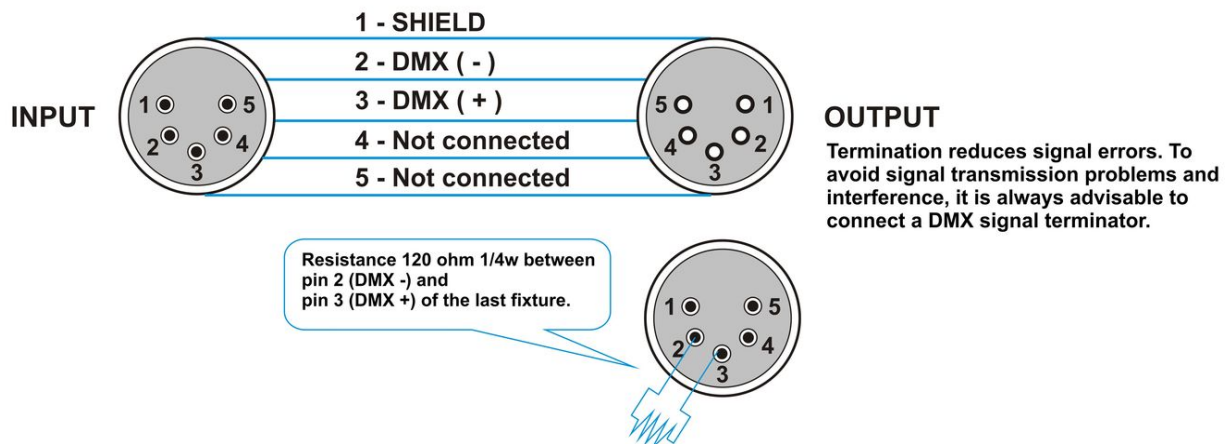

**CAUTION:** Do not allow contact between the common and the fixture's chassis ground. Grounding the common can cause a ground loop, and your fixture may perform erratically. Test cables with an ohm meter to verify correct polarity and to make sure the pins are not grounded or shorted to the shield or each other.

## 3-PIN TO 5-PIN CONVERSION CHART

If using a console with a 3-pin DMX output connector, a 3-pin to 5-pin adapter is needed. The chart below details a proper cable conversion:

### 3-PIN TO 5-PIN CONVERSION CHART

Conductor	3 Pin Female (output)	5 Pin Male (Input)
Ground / Shield	Pin 1	Pin 1
Data ( - ) signal	Pin 2	Pin 2
Data ( + ) signal	Pin 3	Pin 3
Do not use		Do not use
Do not use		Do not use

## SETTING UP A DMX SERIAL DATA LINK

1. Connect the (male) 5-pin connector side of the DMX cable to the output (female) 5-pin connector of the DMX console.
2. Connect the opposite end of the cable (female) to the input connector of the fixture consisting of a (male) 5-pin connector.
3. Proceed to connect from the fixture output as stated above to the input of the following fixture and so on.
4. Continue linking until the last fixture is connected in your DMX chain.

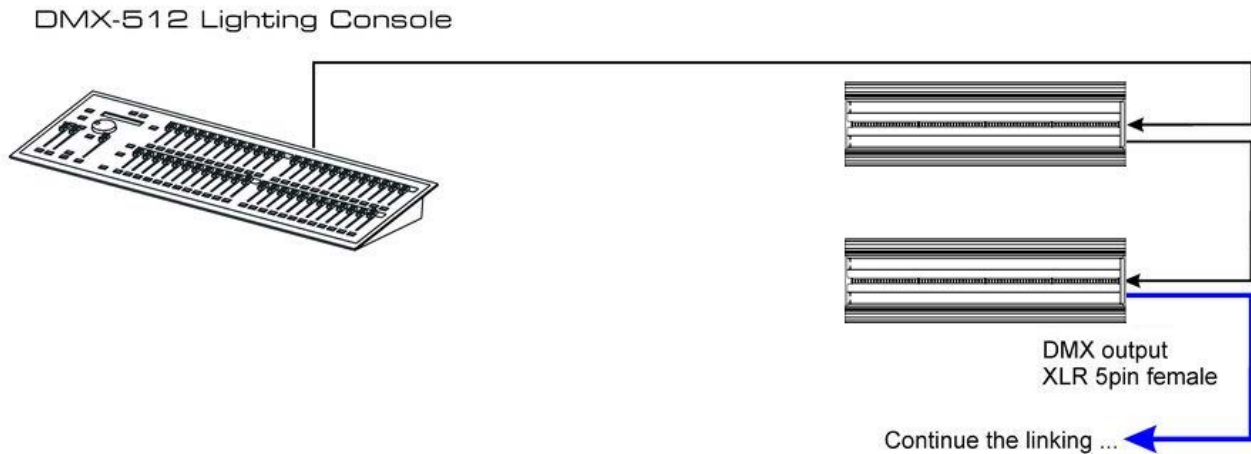

## FIXTURE MOUNTING / RIGGING

### Orientation

Solaris SoLED fixtures may be mounted in any position. Always make sure there is adequate room for ventilation. Do not obstruct the unit's vents.

### Support Stand

Always use a professional stand rated to support weight greater than the SoLED weight (4.77 lb. / 2.15 kg). Attach a TVMP spigot to the yoke of the SoLED and mount on the stand.

**Rigging** – Always consult a qualified rigging specialist before suspending any fixture overhead.

Use ProBurger® couplers or equivalent C- or O-type clamps for attaching to truss. Do not obstruct vents. Adjust the fixture angle by loosening both knobs and tilting the fixture as needed. After establishing the desired position, retighten both knobs.

- Always use safety cables!
- When selecting installation location, consider routine maintenance.
- Never mount fixture where it will be exposed to moisture, high humidity, extreme temperatures, or restricted ventilation.



## 3. OPERATING INSTRUCTIONS

### CONTROL PANEL NAVIGATION

Access control panel functions via four control panel buttons surrounding the LCD display. Buttons are indicated by a concentric circle.

The control panel LCD display shows the menu items selected from the menu map (page 8). When a menu function is selected, the display will show the first available option for the selected menu function. To select a menu item, press <MENU>.

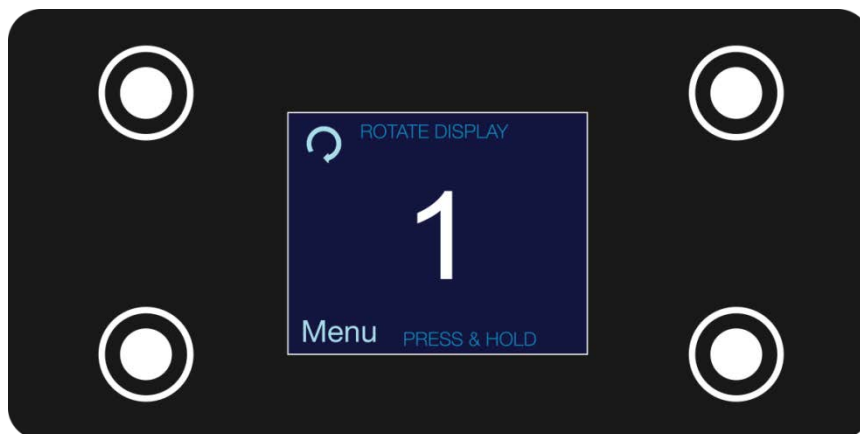

Press and hold the **<MENU>** button to access the top level menu items.

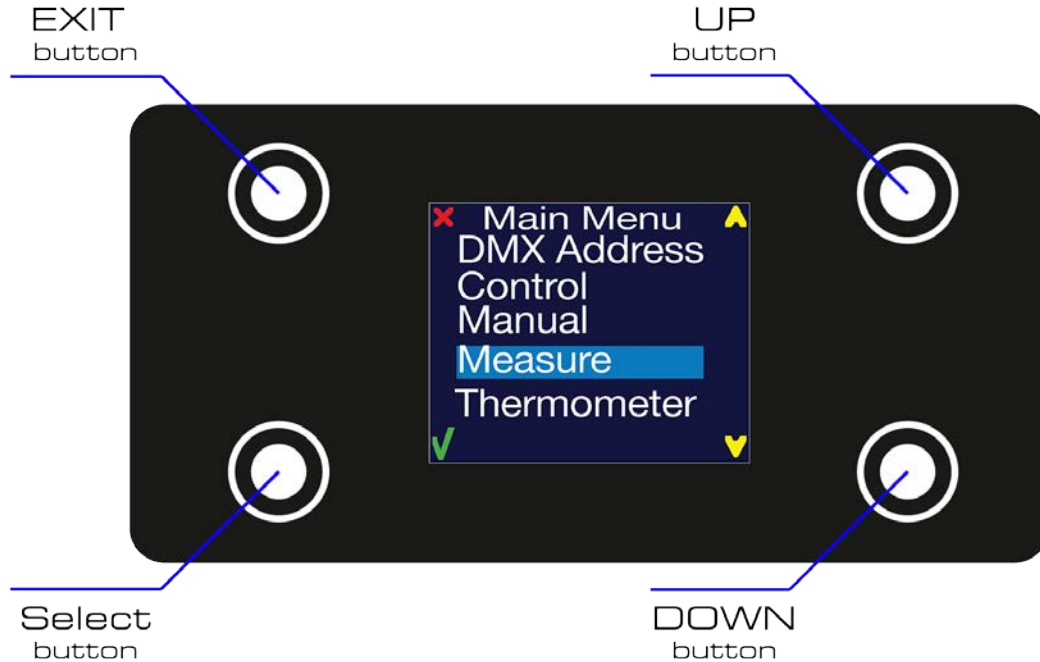

Use the **<UP>** and **<DOWN>** buttons, located to the right of the LCD screen, to navigate the menu map and menu options. Press the **<✓>** button to access the menu function currently displayed, or to enable a menu option. To return to the top of the menu map or menu without changing the value, press the **< X >** button.

## MAIN MENU FUNCTIONS:

**DMX Address** – DMX Address selection menu

**Control**– Control mode selection menu

**Manual**– Gives manual control of device

**Measure** – Shows system measurements

**Thermometer** – Shows current temperature

During normal operation the control panel LCD display indicates the DMX start address of the SoLED. When the DMX signal is not connected, or if the Solaris is not receiving a DMX signal, the SoLED blinks RED.



## MENU MAP

Level 1	Level 2	Level 3	Notes
DMX Address	1-512		Set the DMX start address
Control			In this menu function fixture control options can be selected
	DC		DMX mode is set to 1 channel (Intensity)
	F3		DMX mode is set to 3 channels (Int+Dur+Rate)
	F4		DMX mode is set to 4 channels (Int+Dur+Rate+Eff)
Manual			Manual control of fixture effects. Stand-alone function.
	Int	0-255	Set strobe intensity
	Dur	0-255	Set strobe duration
	Rate	0-255	Set strobe rate
	Eff	0-255	Set strobe effects
Measure			Displays system measurements (input voltage, frequency, temperate, etc.)
Thermometer			Shows current temperature of device

### DURATION TIME: RATE TIME RELATION.

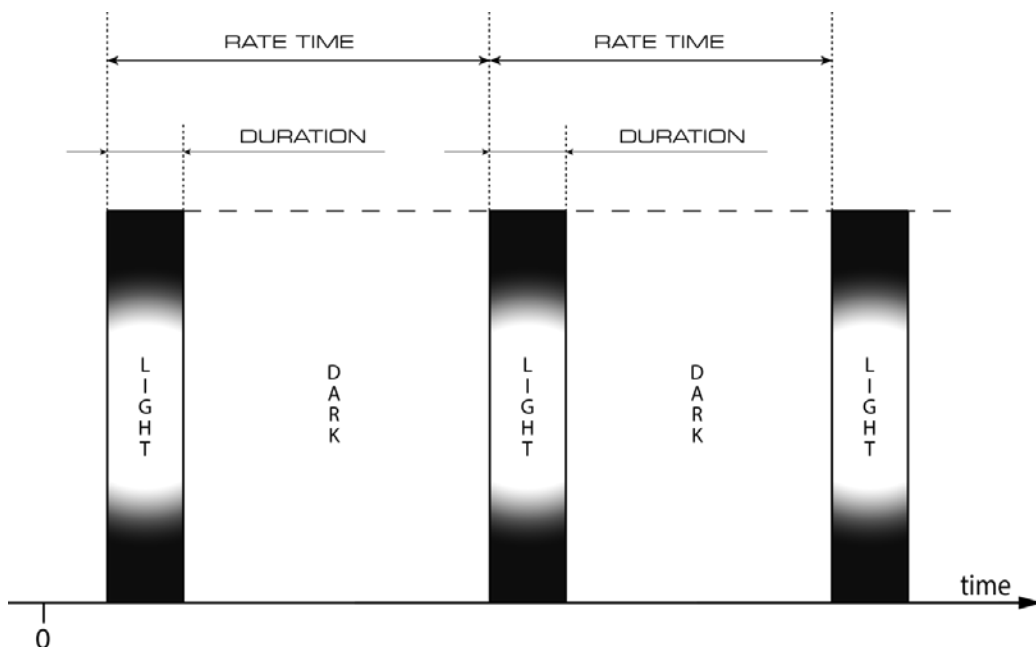

## FUNCTION DESCRIPTION

### DMX ADDRESS

To set the required DMX Address, you must:

- 1) Press and hold **<MENU>** button to open the **Main Menu**.
- 2) Use **<UP>** and **<DOWN>** buttons to find the **DMX Address** submenu.



- 3) Press **<✓>** button to access the DMX Address value change submenu.
- 4) Use **<UP>** and **<DOWN>** buttons to set necessary DMX Address value (e.g. DMX Address 1).

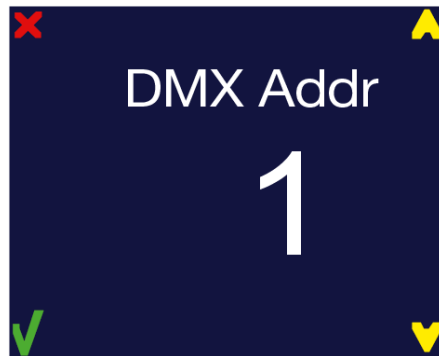

- 5) Use **<✓>** button to confirm new DMX Address.
- 6) When the new DMX Address is confirmed return to Main Menu. Press **< X >** button to return fixture at the work state.
- 7) At work state, control panel display shows current DMX Address, in this case **1**.

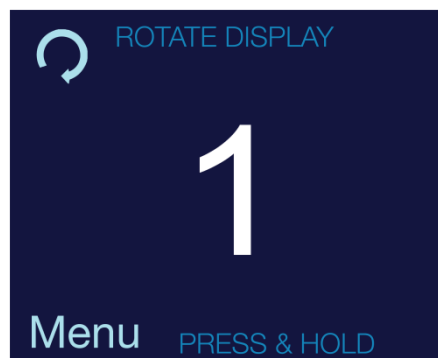

## CONTROL

SoLED has three control modes:

- **DC** (Intensity control only at 2400Hz flicker-free mode)
- **F3** (Intensity, Duration, Rate)
- **F4** (Intensity, Duration, Rate, Effects – includes DC mode in Effects).

To switch between SoLED control modes, do following:

- 1) Press and hold **<MENU>** button to open the Main Menu.
- 2) Use **<UP>** and **<DOWN>** buttons to find the **Control** submenu and press **<✓>** button.



- 3) Now the Control submenu is opened

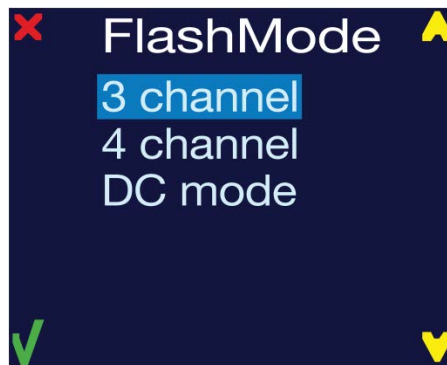

- 5) Choose one of these three operating modes.
- 6) When new mode is confirmed using the **<✓>** button, you return to Main Menu. Press **<X>** button to return the fixture to work state.
- 7) At the work state, the control panel display shows current DMX Address, in this case **1**.

## STROBE MODES

Three or four channels control strobe parameters:

- Strobe Intensity
- Strobe Duration
- Strobe Rate
- Strobe FX (only in F4, 4-channel mode)

Channel	DMX Values	Percent	Strobe Function
<b>First Strobe Channel</b>	0 - 5 6 - 255	0 - 1 2 - 100	<b>Flash intensity</b> Blackout (0-7 DMX in DC Mode) Intensity level (8-255 in DC Mode)
<b>Second Strobe Channel</b>	0 - 255	0 - 100	<b>Flash duration</b> 0 - 650ms (50Hz AC) 0 - 530ms (60Hz AC)
<b>Third Strobe Channel</b>	0 - 5 6 - 255	0 - 1 2 - 100	<b>Flash rate</b> No flash 0.5 - 25 Hz (50Hz AC) 0.6 - 30 Hz (60Hz AC)
<b>Fourth Strobe Channel (Only on F4 mode)</b>	0 - 5 6 - 42 43 - 85 86 - 128 129 - 171 172 - 214 215 - 250 251 - 255	0 - 2 16-33 17 - 33 34 - 50 51 - 67 68 - 84 85 - 97 98 - 100	<b>Flash effects</b> No effect Ramp up Ramp down Ramp up – down Random Lightning Spikes DC Mode Override- v.4.0 software or higher

## SPECIAL EFFECTS DESCRIPTIONS:

- **Ramp up:** Light gradually increases in intensity, then blacks out.
- **Ramp down:** Light flashes to full intensity, then gradually fades.
- **Ramp up-down:** Light gradually increases and decreases.
- **Random flash:** Light flashes randomly at variable rate and intensity. Multiple units flash independently.
- **Lightning:** Flashes simulate lightning. Duration is not adjustable.

- **Spikes:** Lamp remains dimly illuminated between flashes. Set flash intensity, duration, and rate as normal.
- **DC MODE Override:** Lamp changes to 2400Hz flicker-free mode. This mode uses the intensity channel of F4 mode to scale the intensity from 0 – 100%. Strobe Rate, Duration, and Effects are bypassed. Fixture will remain at a constant intensity unless it senses a thermal limit being hit and will throttle itself down in intensity back to operational specs. This mode will exhibit stepping, especially in the lower range of the intensity channel due to the nature of the near pure-DC operation of the LEDs.

**NOTE: If fixture senses over-limit thermal operation, smart-limiting activates and throttles the fixture down to safe operating levels. The fixture allows full output bursts if the temperature is within operating specifications.**

## MANUAL MODE

Manual Mode allows control of SoLED without a controlling device. In this menu, manually select strobe intensity, duration, and rate between strobe and other effects (see page 12). Manual Mode is a stand-alone mode; values are saved if power is interrupted. “Reset” will clear Manual Mode values.

Manual function includes four settings:

- **Int** (intensity of strobe)
- **Dur** (duration of strobe)
- **Rate** (duration between flashes)
- **Eff** (special effect channel (see table on page 14))

- 1) Press and hold **<MENU>** button to open the Main Menu.
- 2) Use **<UP>** and **<DOWN>** buttons to find the Manual submenu and press the **<✓>** button.
- 3) Manual Mode submenu will open.
  - **Int** (Intensity)
  - **Dur** (Duration)
  - **Rate**
  - **Eff** (Effects, FX)



- 4) Manual Mode submenu will open.
  - **Int** (Intensity)
  - **Dur** (Duration)
  - **Rate**
  - **Eff** (Effects(FX))

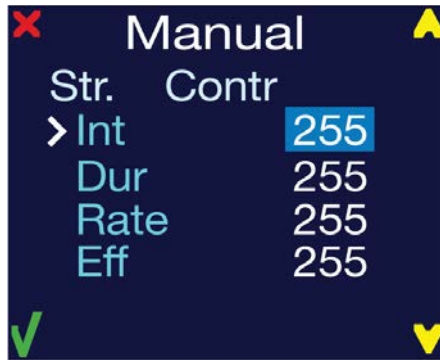

Settings values are converted to percentages (e.g. 255=100%; 0=0%)

FX effects have specific values:

Flash effects (FX)		
0 - 5	0 - 2	No effect
6 - 42	3 - 16	Ramp up
43 - 85	17 - 33	Ramp down
86 - 128	34 - 50	Ramp up
129 - 171	51 - 67	Ramp down
172 - 214	68 - 84	Ramp up-down
215 - 251	85 - 97	Random
252 - 255	98 - 100	Lightning
		Spikes
		DC mode Override

**To edit values, do following:**

Use <UP> and <DOWN> buttons to select the strobe function to be modified.

Press < ✓ > button.

Press <UP> and <DOWN> buttons to modify the value (255=100%; 0=0%; for FX see above).

Repeat with all settings until desired effect is achieved.

Press < ✓ > button once more to exit editing the current value and to lock in the desired value

Follow the above steps to edit other values.

Press < X > button to exit Manual Mode.

## DURATION TIME: RATE TIME RELATION.

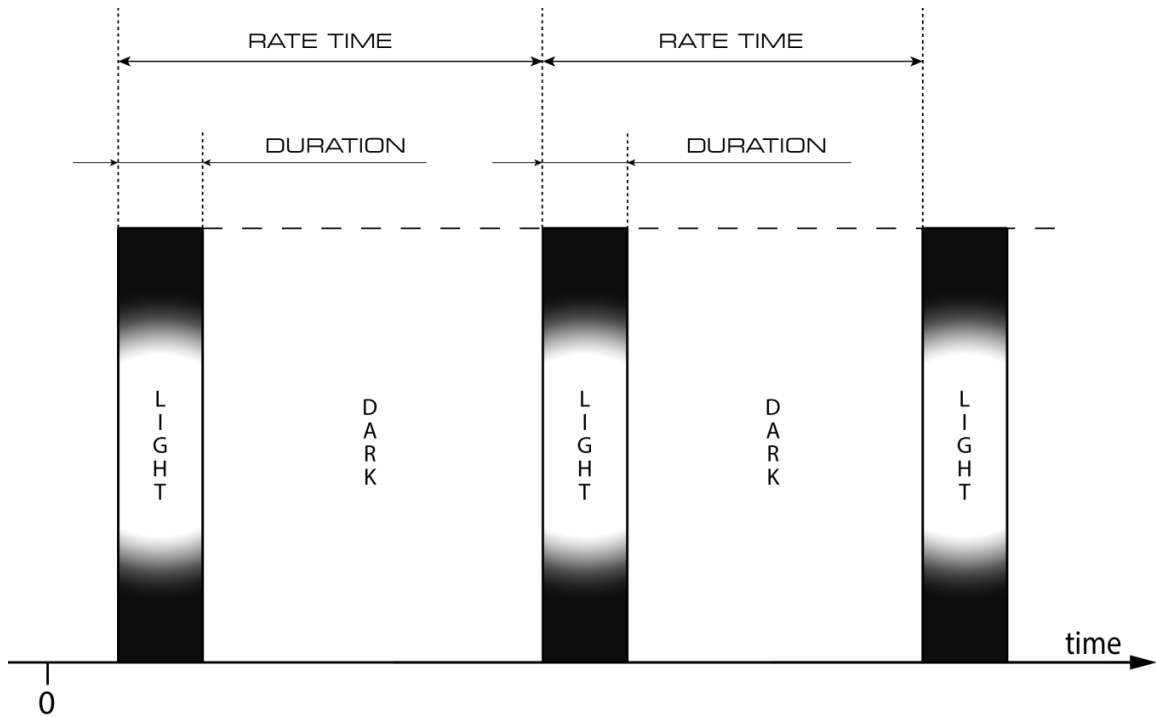

## MEASURE

This submenu shows all possible sensor values.

- 1) Press and hold **<MENU>** button to open the **Main Menu**.
- 2) Use **<UP>** and **<DOWN>** buttons to find the **Measure** submenu and press **<✓>** button.



Indicated are Input voltage (**U<sub>in</sub>**); frequency (**Frq**); temperature (**T**) / power (**P**); and power limiting (**Plim**). If SoLED overheats, output power will automatically decrease.

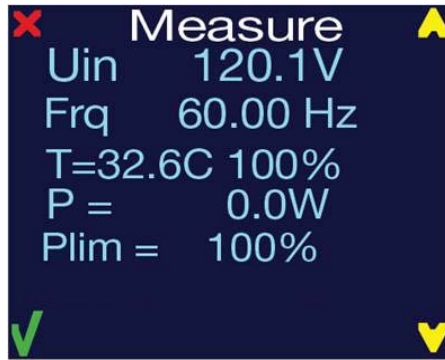

3) To change temperature scale from Celsius to Fahrenheit, press <UP> or <DOWN> buttons.



## THERMOMETER

- 1) Press and hold <MENU> button to open the **Main Menu**.
- 2) Use <UP> and <DOWN> buttons to find the **Thermometer** submenu and press select button.





This setting shows operating temperature of the device. To change temperature readings between Celsius and Fahrenheit, press the <UP> and <DOWN> buttons.



## 4. APPENDIX

### GENERAL MAINTENANCE

To maintain optimum performance and minimize wear fixtures should be cleaned frequently. Usage and environment are contributing factors in determining frequency. As a general rule, fixtures should be cleaned at least twice a month. Dust build up reduces light output performance and can cause overheating. This can lead to reduced lamp life and increased mechanical wear. Be sure to disconnect power to the fixture before conducting maintenance.

Unplug fixture from power. Use a vacuum or air compressor and a soft brush to remove any dust on external vents and internal components. Clean all glass when the fixture is cold with a mild solution of glass cleaner or Isopropyl Alcohol and a soft lint free cotton cloth or lens tissue. Apply solution to the cloth or tissue and drag dirt and grime to the outside of the lens. Gently polish optical surfaces until they are free of haze and lint.

The cleaning of internal and external optical lenses and/or mirrors must be carried out periodically to optimize light output. Cleaning frequency depends on the environment in which the fixture operates: damp, smoky or particularly dirty surroundings can cause greater accumulation of dirt on the unit's optics. Clean with soft cloth using normal glass cleaning fluid. Always dry the parts carefully. Clean the external optics at least every 20 days. Clean the internal optics at least every 30 to 60 days.

### LIMITED WARRANTY

Solaris fixtures are warranted by TMB against defective materials or workmanship for a period of two (2) years from the date of original sale by TMB.

TMB's warranty shall be restricted to the repair or replacement of any part that proves to be defective and for which a claim is submitted to TMB before the expiration of the applicable warranty periods.

This Limited Warranty is void if the defects of the Product are the result of:

- Opening the casing, repair, or adjustment by anyone other than TMB or persons specifically authorized by TMB.
- Accident, physical abuse, mishandling, or misapplication of the product.
- Damage due to lightning, earthquake, flood, terrorism, war, or act of God.

TMB will not assume responsibility for any labor expended, or materials used, to replace and/or repair the Product without TMB's prior written authorization. Any repair of the Product in the field, and any associated labor charges, must be authorized in advance by TMB. Freight costs on warranty repairs are split 50/50: Customer pays to ship defective product to TMB; TMB pays to ship repaired product, ground freight, back to Customer.

This warranty does not cover consequential damages or costs of any kind.

A Return Merchandise Authorization (RMA) Number must be obtained from TMB prior to return of any defective merchandise for warranty or non-warranty repair. For all repairs please contact TMB Tech Support Repair using the contact information below or email TechSupportRepairNA@tmb.com.

#### US

527 Park Ave.  
San Fernando, CA 91340  
Tel: +1 818.899.8818  
Fax: +1 818.899.8813  
tmb-info@tmb.com  
www.tmb.com

#### UK

21 Armstrong Way  
Southall, UB2 4SD England  
Tel: +44 (0)20.8574.9700  
Fax: +44 (0)20.8574.9701  
tmb-info@tmb.com  
www.tmb.com

## RETURN PROCEDURE

Please send returned merchandise prepaid and in the original packing. Freight call tags will not be issued for shipping the product to TMB, but TMB will pay the freight for return to the customer. Clearly label package with a Return Merchandise Authorization Number (RMA #). Products returned without an RMA # will delay service. Please contact TMB and request an RMA # prior to shipping the unit. Be prepared to provide the model number, serial number, and a brief description of the cause for the return. Be sure to properly pack the unit; any shipping damage resulting from inadequate packaging is the customer's responsibility. TMB reserves the right to use its own discretion to repair or replace product(s). Proper UPS packing or double-boxing will better ensure product integrity when shipped.

**Note: If you are given an RMA #, please include the following information on a piece of paper inside the box:**

- 1) Your name
- 2) Your address
- 3) Your phone number
- 4) The RMA #
- 5) A brief description of the symptoms

## CONTACT INFORMATION

### TMB GENERAL INFORMATION

US Phone:	+1 818.899.8818
Fax:	+1 818.899.8813
UK Phone:	+44 (0)20.8574.9700
Fax:	+44 (0)20.8574.9701
e-mail:	tmb-info@tmb.com
web:	www.tmb.com

### TMB 24/7 TECHNICAL SUPPORT

US/Canada:	+1 818.794.1286
Toll Free:	1 877.862.3833 (877.TMB.DUDE)
UK:	+44 (0)20.8574.9739
Toll Free:	0800.652.5418
e-mail:	techsupport@tmb.com

# TECHNICAL SPECIFICATIONS – SOLARIS SoLED, 840W STROBE

## WEIGHT & DIMENSIONS

---

LENGTH..... 14.2 IN / 360 MM  
WIDTH..... 3.7 IN / 95 MM  
HEIGHT..... 31.5 IN / 80 MM  
WEIGHT..... 5.6 LB. / 2.56 KG

## POWER

---

OPERATING VOLTAGE ..... 100-240VAC, 50/60 Hz  
FUSE..... 12A, 250V SLOW-BLOW  
PEAK POWER ..... 840W  
POWER CONNECTORS..... IN POWERCON 20A BLUE

## LIGHT SOURCE

---

LED COUNT ..... 84 CREE XP-L LED'S  
COLORS ..... WHITE  
COLOR TEMPERATURE..... >5700K  
BEAM SPREAD ..... 100°

## THERMAL

---

MAX. AMBIENT TEMPERATURE ..... +104 °F / +40 °C  
MIN. AMBIENT TEMPERATURE ..... -4 °F / -20 °C  
COOLING ..... CONVECTIONAL

## CONTROL & PROGRAMMING

---

CONTROL ..... DMX-512A WITH RDM, MANUAL MODE  
DMX CHANNELS..... 1,3,4  
DMX INPUT..... LOCKING 5-PIN XLR MALE SOCKET  
DMX OUTPUT ..... LOCKING 5-PIN XLR FEMALE SOCKET  
DMX PIN CONFIG ..... PIN 1 SHIELD, PIN 2 (-), PIN 3 (+), PINS 4 & 5 N/A

## WARRANTY INFORMATION

---

WARRANTY..... 2-YEAR LIMITED WARRANTY

## DIMENSIONAL DRAWING

